

**SSS[®] TRIPLE S[®] COMMERCIAL
LIMITED WARRANTY**

WHAT THIS WARRANTY COVERS

Your SSS commercial cleaner is warranted to be free from all defects in material and workmanship in normal use FOR A PERIOD OF ONE YEAR. The warranty is granted only to the original purchaser of the cleaner. The warranty is subject to the following provisions.

WHAT THIS WARRANTY DOES NOT COVER

- Parts of the cleaner that require replacement under normal use, such as bumpers, bags, bristle strips, belts, light bulbs, hoses and impellers.
- Damages or malfunctions caused by negligence, abuse, or use not in accordance with the Owner's Guide.
- Defects or damages caused by unauthorized service or the use of other than authorized parts.

WHAT THE MANUFACTURER WILL DO

The manufacturer will, at its option, repair or replace a defective cleaner or cleaner part that is covered by this warranty. As a matter of warranty policy, the manufacturer will not refund the consumer's purchase price.

OBTAINING WARRANTY SERVICE

To obtain warranty service you must return the defective cleaner or cleaner part along with proof of purchase to your local SSS Distributor.

For the location of the nearest Authorized Distributor or for service information, telephone:

1-800-323-2251

If you prefer, you can write to:

Triple S
2 Executive Park Drive
Billerica, MA 01862

FURTHER LIMITATIONS AND EXCLUSIONS

Any warranty that may be implied in connection with your purchase or use of the cleaner, including any warranty of MERCHANTABILITY or any warranty for FITNESS FOR A PARTICULAR PURPOSE is limited to the duration of this warranty. Some states do not allow limitations on how long an implied warranty lasts, so the above limitations may not apply to you.

Your relief for the breach of this warranty is limited to the relief expressly provided above. IN NO EVENT SHALL THE MANUFACTURER BE LIABLE FOR ANY CONSEQUENTIAL OR INCIDENTAL DAMAGES THAT YOU MAY INCUR IN CONNECTION WITH YOUR PURCHASE OR USE OF THE CLEANER. Some states do not allow the exclusion or limitation of incidental or consequential damages, so the above limitation or exclusion may not apply to you.

This warranty gives you specific legal rights. You may also have other rights which vary by State.

Distributed by:

SSS[®] TRIPLE S[®]
BILLERICA, MA 01862

Part No. 5005C

Printed in U.S.A.

SSS[®] TRIPLE S[®]

BILLERICA, MA 01862

OWNERS GUIDE

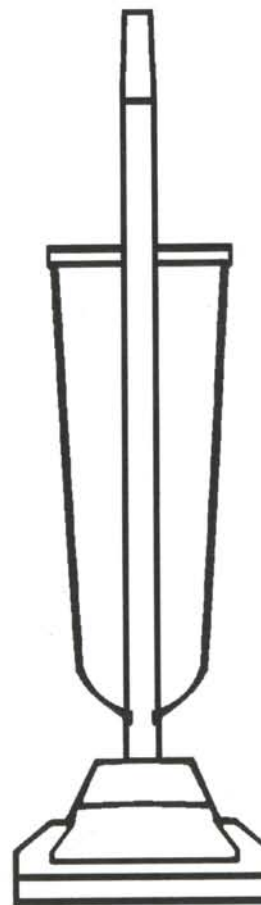

**Model HD-100
Commercial Upright
Vacuum Cleaner**

Index

Important Safeguards	2
Service Information	6
Assemble	6
Use	8
Dust Bag	9
Brush Roll Belt	10
Brush Roll	11
Warranty	12

IMPORTANT SAFEGUARDS

When using an electrical appliance, basic precautions should always be followed, including the following:

READ ALL INSTRUCTIONS BEFORE USING THIS VACUUM CLEANER.

WARNING

To reduce the risk of fire, electric shock, or injury:

- Do not use outdoors or on wet surfaces.
- Do not leave vacuum cleaner when plugged in. Turn off the switch and unplug the electrical cord when not in use and before servicing.
- Do not allow to be used as a toy. Close attention is necessary when used by or near children.
- Use only as described in this manual. Use only manufacturer's recommended attachments.
- Do not use with damaged cord or plug. If vacuum cleaner is not working as it should, has been dropped, damaged, left outdoors, or dropped into water, return it to a service center before using.
- Do not pull or carry by cord, use cord as a handle, close door on cord, or pull cord around sharp edges or corners. Do not run vacuum cleaner over cord. Keep cord away from heated surfaces.
- Connect to a properly grounded outlet only (refer to Grounding Instructions).
- Do not use extension cords or outlets with inadequate current carrying capacity.
- Turn off all controls before unplugging.
- Do not unplug by pulling on cord. To unplug, grasp the plug, not the cord.
- Do not handle plug or vacuum cleaner with wet hands.
- Do not put any object into openings. Do not use with any opening blocked; keep free of dust, lint, hair, and anything that may reduce airflow.
- This vacuum cleaner creates suction and contains a revolving brush roll. Keep hair, loose clothing, fingers, and all parts of body away from openings and moving parts.
- Do not pick up anything that is burning or smoking, such as cigarettes, matches, or hot ashes.
- Do not use without dust bag in place.
- Belt pulleys can become hot during normal use. To prevent burns, avoid touching the belt pulley when servicing the drive belt.
- Use extra care when cleaning on stairs.
- Do not use to pick up flammable or combustible liquids such as gasoline, or use in areas where they may be present.
- Store your cleaner indoors in a cool, dry area.
- Keep your work area well lighted.
- Unplug electrical appliances before vacuuming them.

SAVE THESE INSTRUCTIONS

Grounding Instructions

This appliance must be grounded. If it should malfunction or breakdown, grounding provides a path of least resistance for electric current to reduce the risk of electric shock. This appliance is equipped with a cord having an equipment-grounding conductor and grounding plug. The plug must be plugged into an appropriate outlet that is properly installed and grounded in accordance with all local codes and ordinances.

DANGER

Improper connection of an equipment-grounding conductor can result in risk of electric shock. Check with a qualified electrician or service person if you are in doubt as to whether the outlet is properly grounded. Do not modify the plug provided with the appliance. If it will not fit the outlet, have proper outlet installed by a qualified technician.

This appliance is for use on a nominal 120 volt circuit and has a grounding plug that looks like the plug illustrated in Figure A. A temporary adapter which looks like the adapter illustrated in Figure B may be used to connect this plug to a two-pole receptacle, as shown, if a properly grounded outlet is not available. The temporary adapter should be used only until a properly grounded outlet, Figure A, can be installed by a qualified electrician. The green colored rigid ear, lug, or the like extending from the adapter must be connected to a permanent ground such as a properly grounded outlet box cover. Whenever the adapter is used, it must be held in place by a metal screw.

NOTE: In Canada, the use of a temporary adapter is not permitted by the Canadian Electrical Code.

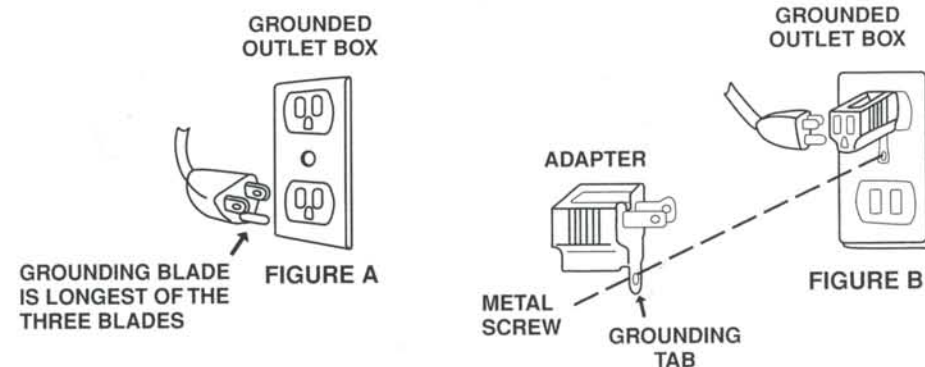

CONSEILS DE SÉCURITÉ

Lors de l'utilisation d'un appareil électrique, quelques précautions élémentaires doivent être observées, incluant les suivantes:

LISEZ TOUTES LES INSTRUCTIONS AVANT D'UTILISER VOTRE ASPIRATEUR.

AVERTISSEMENT

Pour réduire le risque de feu, de choc électrique, ou de blessure:

- Ne pas utiliser à l'extérieur ou sur des surfaces mouillées.
- Fermez le commutateur et débranchez l'appareil lorsque vous ne l'utilisez pas ou avant le nettoyage ou l'entretien.
- Ne permettez pas qu'il soit utilisé comme jouet. Une attention particulière est nécessaire lorsque utilisé par ou près d'un enfant.
- Suivez les recommandations d'utilisation de ce manuel. Utilisez uniquement les accessoires recommandés par le fabricant.
- Ne pas utiliser si le cordon ou la fiche sont endommagés. Si l'aspirateur ne fonctionne pas comme il le devrait, s'il a été échappé, s'il est endommagé, s'il a été laissé l'extérieur ou échappé dans l'eau, retournez-le à un centre de service avant d'utiliser.
- Ne pas le tirer ou le transporter par le cordon, ne pas utiliser le cordon en guise de poignée. Ne pas fermer une porte sur le cordon ou tirer le cordon sur des coins ou bordures pointus. Ne pas circuler sur le cordon avec l'aspirateur. Tenir le cordon à distance des surfaces chauffantes.
- Branchez toujours l'aspirateur dans une prise à trois (mise à la terre).
- Ne pas utiliser des rallonges ou des prises qui n'ont pas de capacité suffisante pour transporter le courant.
- Fermer tous les contrôles avant débrancher.
- Ne pas débrancher en tirant sur le cordon. Pour débrancher, tenez la fiche et non le cordon.
- Ne pas manipuler la fiche ou l'aspirateur avec les mains mouillées.
- Ne pas rien insérer dans les ouvertures. Ne pas utiliser si des ouvertures sont bloquées; assurez-vous qu'elles soient dégagées de poussière, mousse, cheveux ou toute autre chose qui pourrait réduire le passage de l'air.
- Cet aspirateur crée de la succion et contient un rouleau-brosse tournant. Tenir les parties mobiles et les ouvertures loin des cheveux, du linge, des doigts et de toute partie du corps.
- Ne pas ramasser des objets qui brûlent ou fument comme les cigarettes, alumettes ou cendres chaudes.
- N'utilisez pas sans le sac de poussière en place.
- Les poulies du courroie peuvent devenir chaudes pendant l'utilisation normale. Pour prévenir des brûlures, évitez de touché la poulie du courroie lorsque vous réparez la courroie.
- Portez une attention particulière lorsque vous nettoyez les escaliers.
- Ne pas utiliser pour ramasser des liquides inflammables ou combustibles comme de l'essence: Ne pas utiliser dans les endroits où ces liquides pourraient être présents.
- Entrez votre aspirateur à l'intérieur dans un endroit propre et sec.
- Maintenez un bon éclairage à l'endroit où vous travaillez.
- Débrancher les appareils électrique avant de les balayer.

CONSERVEZ CES INSTRUCTIONS

INSTRUCTIONS VISANT LA MISE À LA TERRE

Cet appareil doit être mis à la terre. En cas défaillance ou de panne éventuelles, la mise à la terre fournit au courant un chemin de moindre résistance qui réduit le risque de choc électrique. Cet appareil est pourvu d'un cordon muni d'un conducteur de terre et d'une fiche avec broche de terre. La fiche doit être branchée dans une prise appropriée correctement installée et mise à la terre conformément aux règlements et ordonnances municipaux.

AVERTISSEMENT

Un conducteur de terre mal raccordé peut entraîner un risque de choc électrique. Consulter un électricien ou un technicien d'entretien qualifié si vous n'êtes pas certain que la prise est correctement mise à la terre. Ne pas modifier la fiche fournie avec l'appareil-si elle ne peut être insérée dans la prise, faire installer une prise adéquate par un électricien qualifié.

Note. Au Canada, l'utilisation d'un adaptateur temporaire n'est pas autorisée par le Code canadien de l'électricité.

Cet appareil est destiné à un circuit de 120 V et est muni d'une fiche de mise à la terre semblable à celle illustrée par le Figure A. S'assurer que l'appareil est branché à une prise de courant ayant la même configuration que la fiche. Aucun adaptateur ne devrait être utilisé avec cet appareil.

Boîte de Prise de Terre

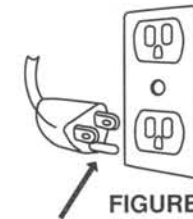

FIGURE A

LA LAME DE TERRE
EST LA PLUS LONGUE
DES TROIS LAMES

GENERAL INFORMATION

The cleaner is designed to pick up dirt and dust particles. Avoid picking up hard or sharp objects with the cleaner to prevent bag tears, hose clogs, and fan blade breakage with subsequent motor damage.

Service Information

To obtain the most satisfying years of service read through these instructions and keep them handy for future reference. If you require service, contact the dealer from whom the cleaner was purchased. **NOTE: Turn off the switch and unplug the electrical cord before servicing the unit.**

 **DO NOT OIL** the motor or the brush roll at any time. The bearings are permanently lubricated and sealed.

Rating Plate

The model, type and serial numbers are indicated on the rating plate located on the bottom of the cleaner. For prompt and complete service information always refer to these numbers when inquiring about service.

MODEL	TYPE	SERIAL NO.
VOLTS	AMPS.	HERTZ
		

Model & Type _____

Serial No. _____

HOW TO ASSEMBLE

Assembly Packet

The assembly packet is with the owner's guide. The packet contains two 2-part bolts and two cord hooks. An extra drive belt is also included with some models.

Step 1 Assemble The Handle

Slip the upper handle and the lower handle together so the handle bolt holes align and the slots in the handle are positioned as shown in Detail A. Insert a 2-part bolt (A) in the center of the handle and tighten.

Hold the assembled handle so it curves away from the cleaner. Then push the handle into the handle socket (D) at the rear of the cleaner. Then push the handle into the handle socket (D) at the rear of the cleaner. Align the holes, insert the other 2-part bolt (A), and tighten.

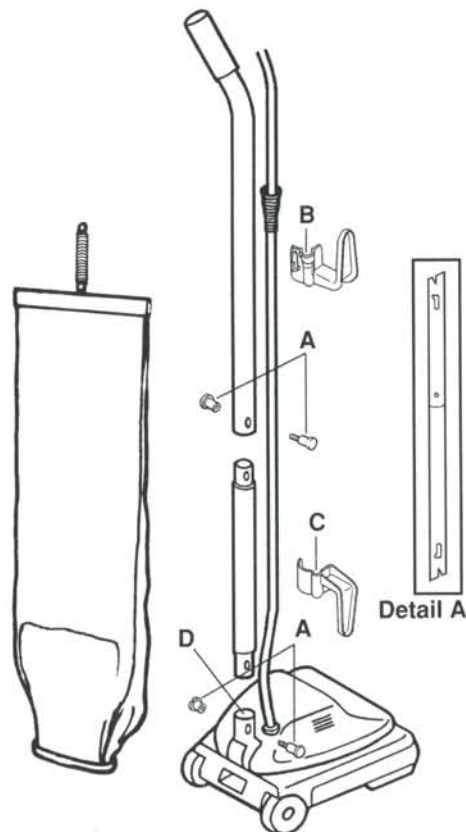

Step 2

Attach Upper Cord Hook

Pull the spring on the electrical cord upward toward the top of the handle. Make sure slots in handle are positioned properly, see Detail A.

Insert the lower half of the spring into the upper cord hook (B), as shown. Snap the hook into the upper handle, directions below.



1. Place inner tab into slot



2. Press hook around handle



3. SNAP opposite inner tab into place

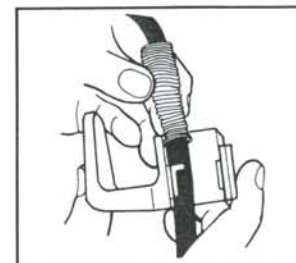

Step 3

Attach Lower Cord Hook

Insert the power cord into the lower cord hook (C), as shown. Snap the hook into the lower handle. Pull up on the cord to tighten but leave enough slack near the base so the cord is not strained when the handle is lowered. Wrap the cord around the two cord hooks. Fasten the plug to the cord to prevent unwinding.

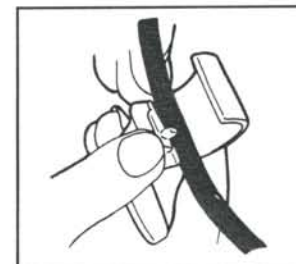

Step 4 Install The Bag

Insert the bag adapter clip (E) on the bottom of the bag collar into the bag adapter retainer (F).

Push the bag collar up and forward so the locator lug slides into the slot indicated by the arrow. Then turn the clam latch (G) to lock the bag onto the rivet (H).

Loop the spring from the top of the bag onto the bag support located to the back of the upper cord hook (B).

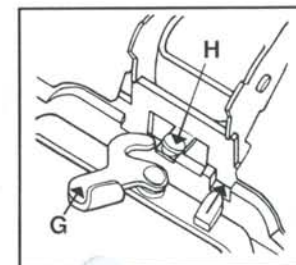
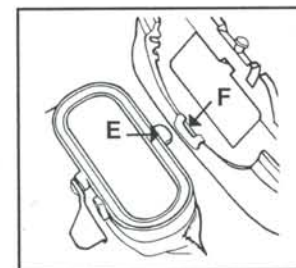

HOW TO USE

The upright vacuum cleaner is designed to be used on multiple types of carpeting. **Do not attempt to use the upright vacuum cleaner on bare floors**, as damage to the floor covering may result. Above the floor cleaning tools are available (optional).

Handle Adjustment

With the tip of the foot, press down to release the handle lock located at the left rear side of the cleaner. Move the handle and adjust it to the desired position for (1) storing upright, (2) operating the cleaner at a comfortable height for the user, and (3) cleaning underneath low furniture.

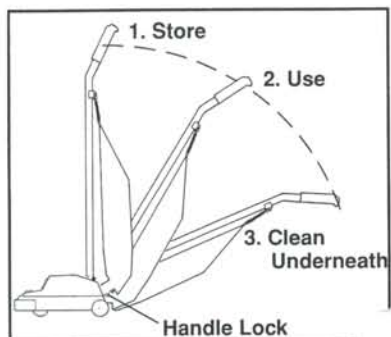

Power Switch

The power switch is mounted on the motor hood. A push with the foot turns the motor ON; push again to turn the motor OFF.

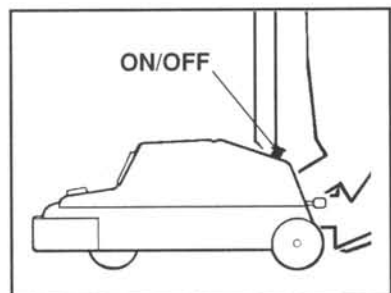

Cord Storage

The cleaner has two convenient cord storage hooks attached to the handle. Wind the cord around the hooks and fasten the plug to the cord to prevent unwinding.

Cleaner Height Setting

WARNING: Avoid injury. Keep loose clothing, hair, fingers, and all other parts of body away from any moving part (such as the revolving brush). Turn off the switch and unplug the cleaner before changing the cleaner height setting.

The front of the cleaner has an adjustment that raises or lowers the cleaner base to match the type of carpet. With the cleaner cord unplugged, set the adjustment to lowest setting for maximum cleaning. If the cleaner is difficult to push, move adjustment to next highest setting until cleaner is comfortable to push. The brush roll must reach the carpet for effective cleaning.

Make each adjustment with cleaner switch off and cord disconnected from outlet. For ease in moving the adjustment knob, place handle in operating position and tilt cleaner back to remove weight from front wheels.

HOW TO MAINTAIN

The instructions given in this booklet serve as a guide to routine maintenance. To avoid unnecessary service calls, check the bag, belt and brush roll often.

Dust Bag

Dust bags play a very important role in the efficiency of a vacuum cleaner. The purpose of the dust bag is to trap dirt. But at the same time the bag fabric must be porous enough to allow air to pass through. If the bag fabric becomes clogged, no air can pass through the cleaner and no cleaning can take place regardless of how powerful the unit is. To keep the cleaner operating at maximum efficiency, empty the dust bag frequently. Some fine particles can restrict airflow very quickly and will decrease performance even before the bag appears to be full. For that reason, when vacuuming carpet fresheners or cleaners, powder, plaster dust, or similar fine substances, the bag may need to be emptied more often.

How To Empty Dust Bag

NOTE: Turn off the switch and unplug the electrical cord before emptying the bag. Never operate the vacuum cleaner without the dust bag.

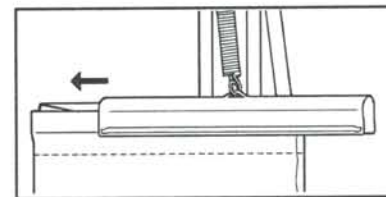

1. Pull bag out open end of clamp

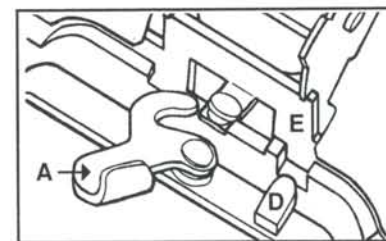

2. Turn cam latch (A) on bag collar to release

3. Place top of bag into appropriate container. Hold bag collar and shake vigorously several times. (Bag can be turned wrong side out and brushed with a whisk broom)

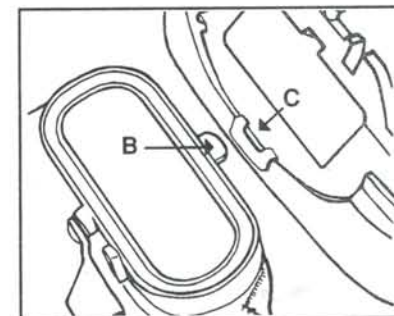

4. Insert bag adapter clip (B) into bag adaptor retainer (C)
5. Push bag collar up and forward so locator lug (D) slides into slot (E)
6. Turn cam latch to lock bag collar onto shoulder rivet
7. Fold top of bag and slide back into clamp

NOTE: Never wash or dry-clean cloth bag.

Brush Roll Belt

The brush roll belt on the upright vacuum cleaner drives the brush to agitate, sweep, and comb the carpet nap. The belt should be checked regularly to be sure it is in good condition. Replace the belt if it is stretching, cracking, or slipping. Cut away any hair or thread wound around the brush roll or the belt pulley because the buildup could cause the belt to rotate unevenly.

How To Replace A Worn Belt

NOTE: Turn off the switch and unplug the electrical cord before replacing belt. Belt pulleys can become hot during normal use. To prevent injury, avoid touching the belt pulley when servicing the drive belt.

IMPORTANT: Improper installation of the brush roll or brush roll belt could cause carpet or cleaner damage.

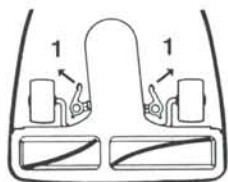

1. Release cam locks

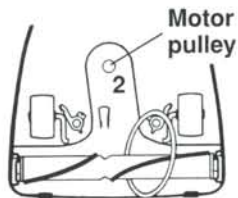

2. Pull up on belt to rotate it off the motor pulley. Lift up on brush roll and remove worn belt.



Check for brush wear (see Brush Roll instructions).

3. Place new belt around brush roll
4. Align brush roll pulley with belt guide



7. Place lower side of belt into belt guide and pull to stretch the belt around the left side of motor pulley. Rotate pulley to secure belt into groove.

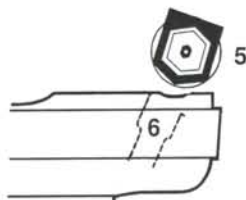

5. Place rubber end cap covers over both end caps (flat side against end cap). Align the holes and secure. Then, slant brush roll forward so end caps are in line with slots in cleaner base.

6. Push brush roll into base.

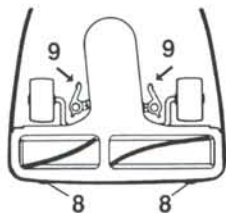

8. Place slots of bottom plate over tabs of cleaner base.
9. Seat and secure cam locks

Ask for replacement belts No. 52100.

Brush Roll

The rotating brush roll sweeps and combs the carpet nap. Keep the brush roll free from hair and threads so it will continue brushing the carpet nap. Replace worn brush strips when the bristles no longer touch a piece of cardboard held across the bottom plate.

How To Replace Worn Brush Strips

NOTE: Turn off the switch and unplug the electrical cord before replacing brush strips.

New brush strips are supplied in sets of two, one long and one short. To replace, remove bottom plate and belt (see How To Change Belt). Then, grasp center of brush roll and lift to remove.

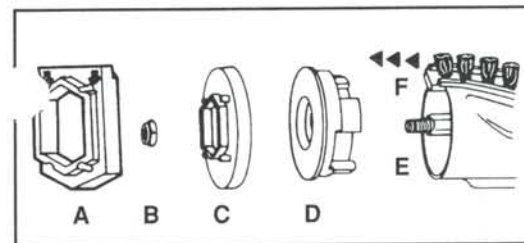

- A. Remove rubber end cap cover from one end
B. Unscrew locknut
C. Remove end cap
D. Remove bearing retainer
E. Push shaft through opposite end
F. Pull out worn brush strip with pliers

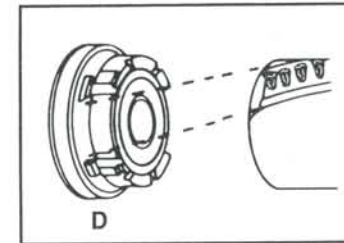

- F. Slide in new brush strip of same length (rounded end first) Fit track on either side into brush roll slot. Replace second brush strip from opposite end of brush roll.
E. Replace shaft
D. Align indentation on bearing retainer with brush strip on both ends of brush roll
C. Position end cap with flat sides of center hole over flat sides of threaded shaft
B. Tighten locknut
A. Align holes and secure rubber end cap cover flat side against end cap

When properly assembled, the brush roll should rotate freely between the two end caps. Check the condition of the belt; change if necessary. Replace the brush roll, belt, and bottom plate (see How To Replace A Worn Belt).

Ask for replacement brush strip No. 52282-2.

Cleaner Care

NOTE: Turn off the switch and unplug the electrical cord before cleaning unit.

To keep the vacuum cleaner looking new, it can be wiped with a damp cloth and a mild soap solution, then thoroughly dried. Never use any type of chemical as chemicals can damage the cleaner. When not in use, the cleaner should be stored in a clean, dry place.

Brush Roll Belt

The brush roll belt on the upright vacuum cleaner drives the brush to agitate, sweep, and comb the carpet nap. The belt should be checked regularly to be sure it is in good condition. Replace the belt if it is stretching, cracking, or slipping. Cut away any hair or thread wound around the brush roll or the belt pulley because the buildup could cause the belt to rotate unevenly.

How To Replace A Worn Belt

NOTE: Turn off the switch and unplug the electrical cord before replacing belt. Belt pulleys can become hot during normal use. To prevent injury, avoid touching the belt pulley when servicing the drive belt.

IMPORTANT: Improper installation of the brush roll or brush roll belt could cause carpet or cleaner damage.

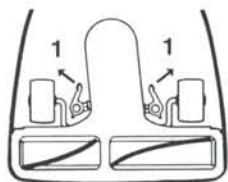

1. Release cam locks



Check for brush wear (see Brush Roll instructions).

3. Place new belt around brush roll
4. Align brush roll pulley with belt guide



7. Place lower side of belt into belt guide and pull to stretch the belt around the left side of motor pulley. Rotate pulley to secure belt into groove.

Ask for replacement belts No. 52100.

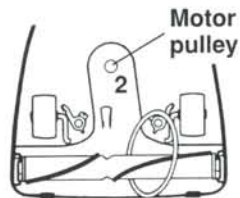

2. Pull up on belt to rotate it off the motor pulley. Lift up on brush roll and remove worn belt.

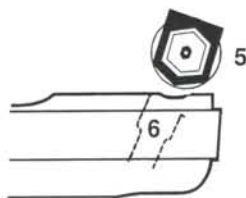

5. Place rubber end cap covers over both end caps (flat side against end cap). Align the holes and secure. Then, slant brush roll forward so end caps are in line with slots in cleaner base.
6. Push brush roll into base.

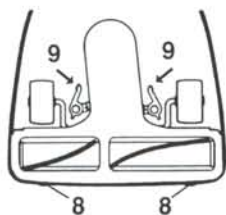

8. Place slots of bottom plate over tabs of cleaner base.
9. Seat and secure cam locks

Brush Roll

The rotating brush roll sweeps and combs the carpet nap. Keep the brush roll free from hair and threads so it will continue brushing the carpet nap. Replace worn brush strips when the bristles no longer touch a piece of cardboard held across the bottom plate.

How To Replace Worn Brush Strips

NOTE: Turn off the switch and unplug the electrical cord before replacing brush strips.

New brush strips are supplied in sets of two, one long and one short. To replace, remove bottom plate and belt (see How To Change Belt). Then, grasp center of brush roll and lift to remove.

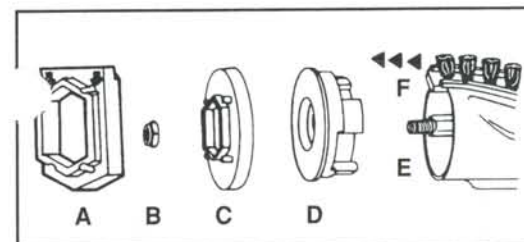

- A. Remove rubber end cap cover from one end
- B. Unscrew locknut
- C. Remove end cap
- D. Remove bearing retainer
- E. Push shaft through opposite end
- F. Pull out worn brush strip with pliers

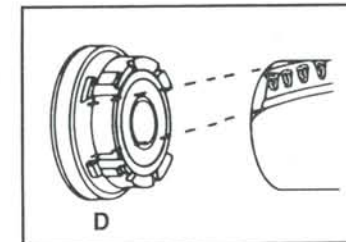

- F. Slide in new brush strip of same length (rounded end first) Fit track on either side into brush roll slot. Replace second brush strip from opposite end of brush roll.
- E. Replace shaft
- D. Align indentation on bearing retainer with brush strip on both ends of brush roll
- C. Position end cap with flat sides of center hole over flat sides of threaded shaft
- B. Tighten locknut
- A. Align holes and secure rubber end cap cover flat side against end cap

When properly assembled, the brush roll should rotate freely between the two end caps. Check the condition of the belt; change if necessary. Replace the brush roll, belt, and bottom plate (see How To Replace A Worn Belt).

Ask for replacement brush strip No. 52282-2.

Cleaner Care

NOTE: Turn off the switch and unplug the electrical cord before cleaning unit.

To keep the vacuum cleaner looking new, it can be wiped with a damp cloth and a mild soap solution, then thoroughly dried. Never use any type of chemical as chemicals can damage the cleaner. When not in use, the cleaner should be stored in a clean, dry place.